

ON		
1		0.003V
2		4.99V
3		4.99V
	1#	28

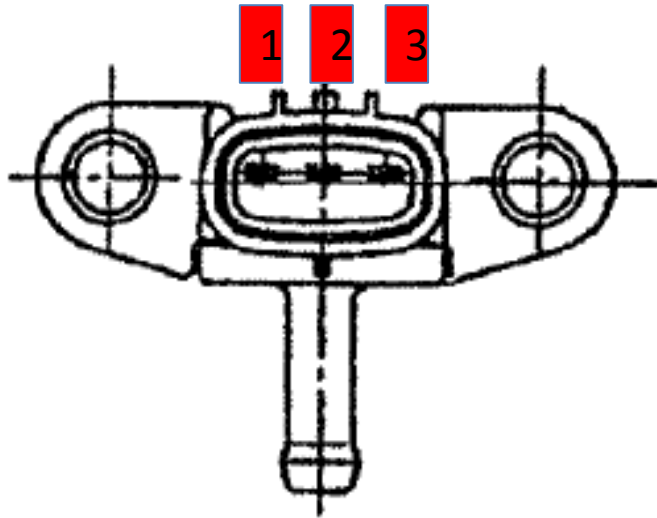

1	2	2.37
1	3	8.8
2	1	2.37
2	3	10.7
3	1	8.9
3	2	10.7

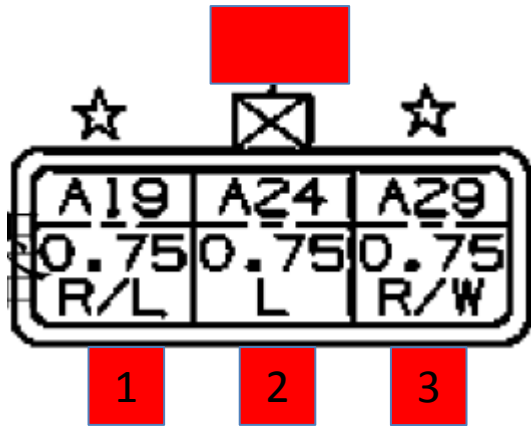

ON		
1		0V
2		0.94V
3		4.9V

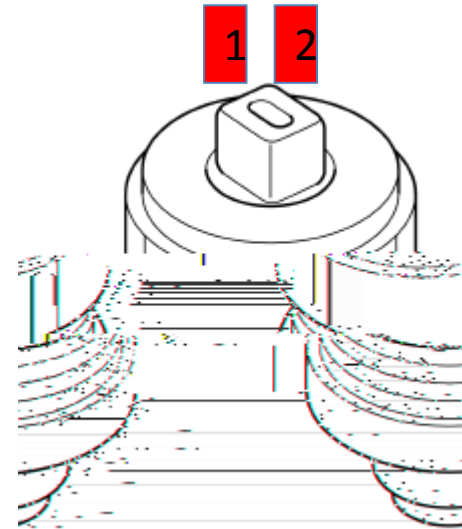
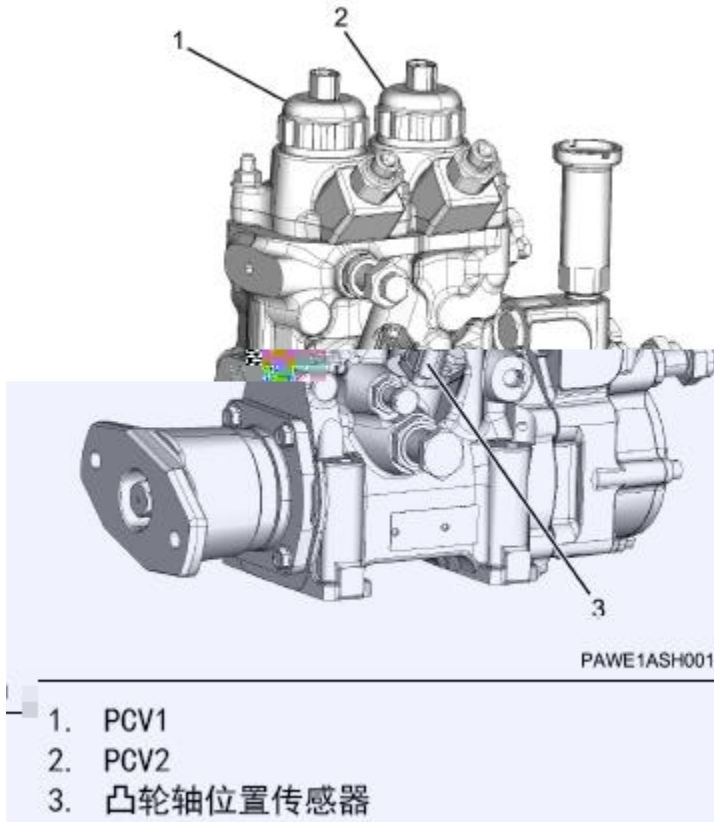

PCV		
1	2	3
2	1	3

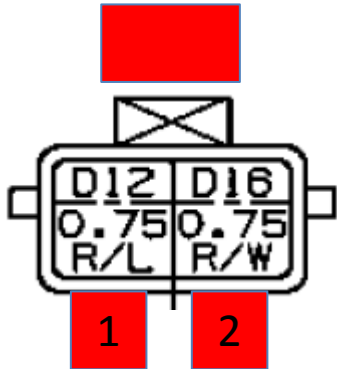

PCV		ON
1		24V
2		0.003V
	2	45.5

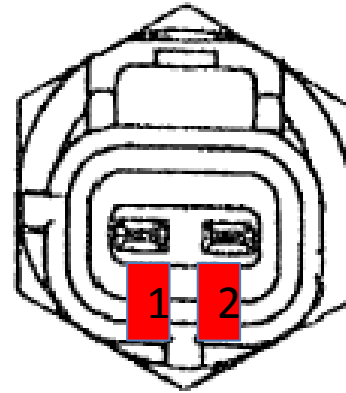
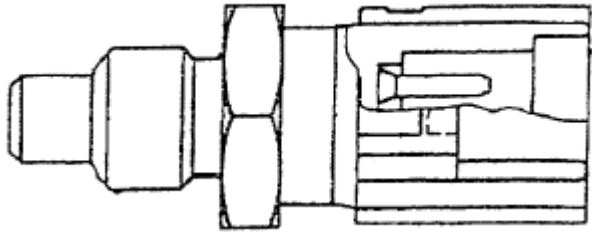

15		
1	2	2.83
2	1	2.83

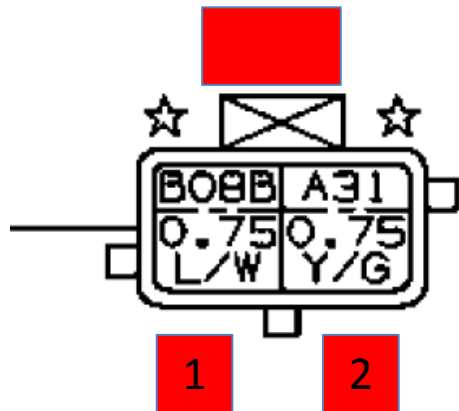

ON		
1		0.002V
2		4.95V

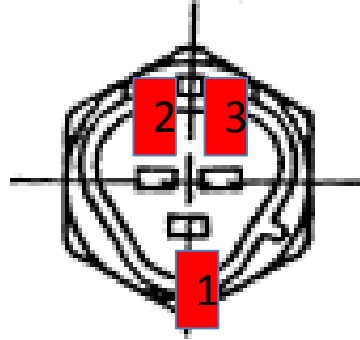
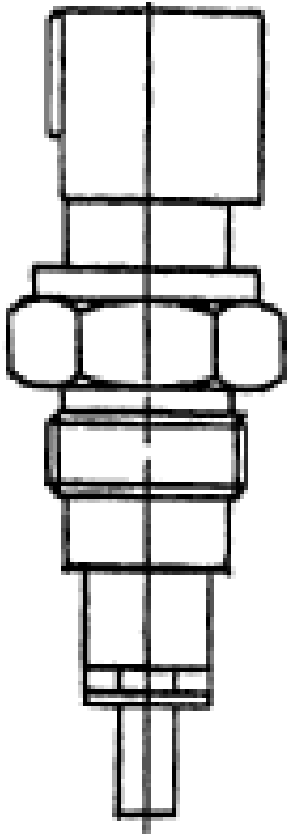

1	3	
1	2	
2	3	1.8
2	1	
3	1	
3	2	1.8

※ 本図は、本機の標準仕様を示すもので、実際の仕様とは異なる場合があります。

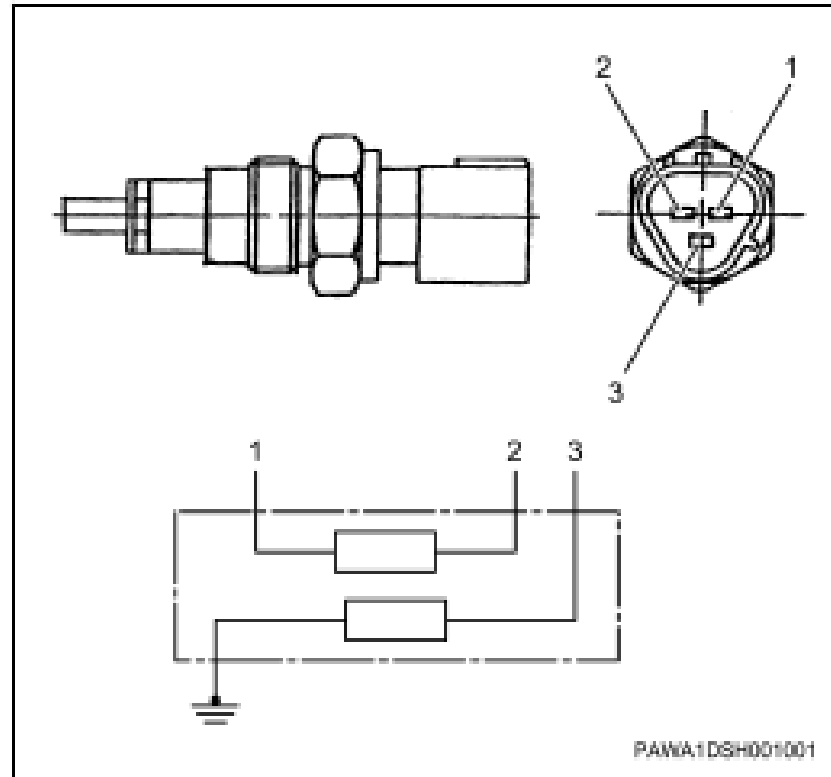

1. 发动机控制接地端子
2. 发动机控制信号端子
3. 仪表信号端子

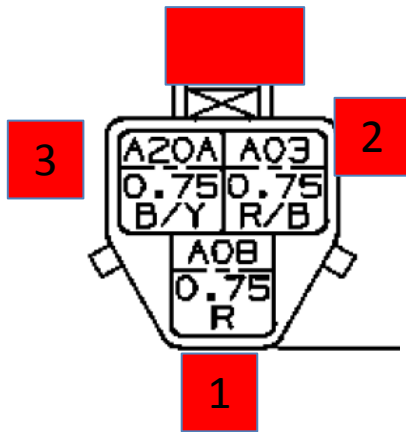

ON			
1	OEM		0.005V
2	ECM		4.97V
3			0.02V
3#			

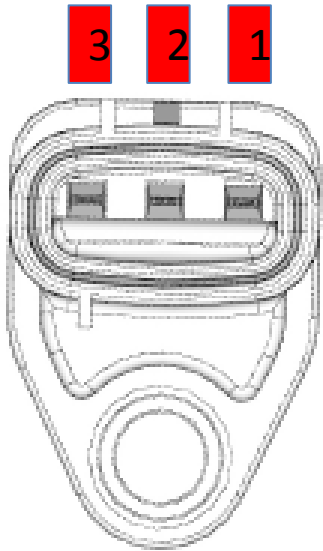

1	2	
1	3	
2	1	25
2	3	0.93
3	1	21
3	2	0.9

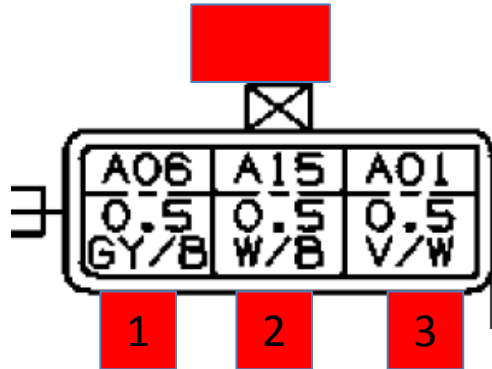

ON		
1		4.99V
2		0.003V
3		4.99V

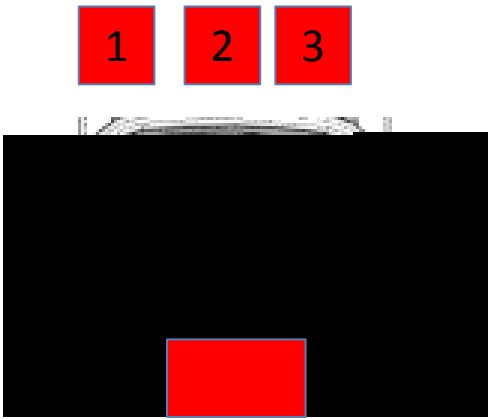

1	2	
1	3	
2	1	25
2	3	0.93
3	1	21
3	2	0.9

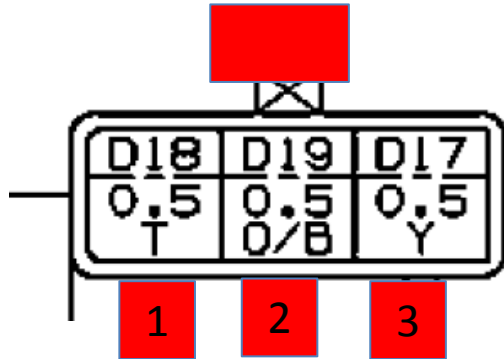

ON		
1		4.95V
2		0.014V
3		4.92V

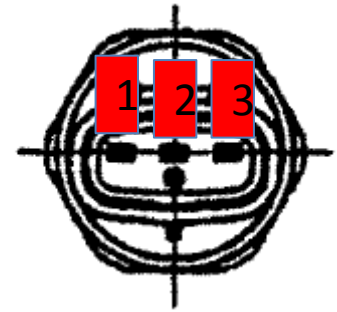
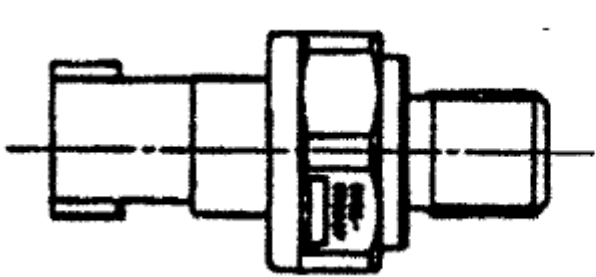

1	2	2.2
1	3	9.8
2	1	2.3
2	3	11
3	1	9.8
3	2	11

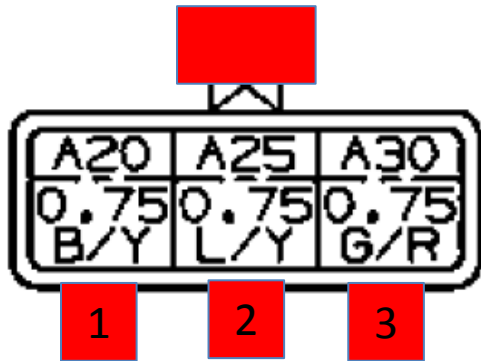

ON		
1		0V
2		0.7V
3		4.99V
1#		

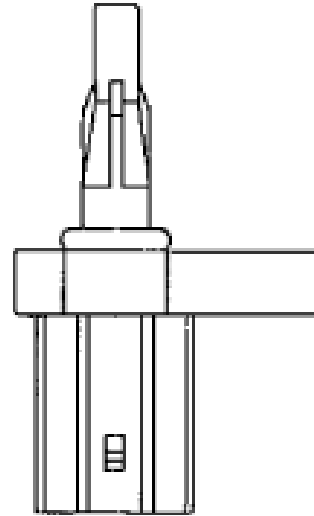
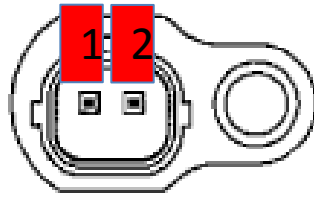

8		
1	2	4.2
2	1	4.2

ON		
1		0.002V
2		4.95V

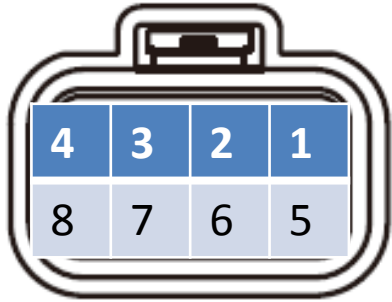

1	2	
1	3	
1	4	
1	5	
1	6	
1	7	
1	8	
2	1	
2	3	0.4
2	4	0.5
2	5	
2	6	1.2
2	7	1.1
2	8	

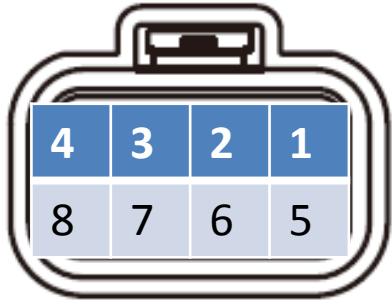

3	1	
3	2	0.5
3	4	0.0
3	5	
3	6	0.5
3	7	0.5
3	8	
4	1	
4	2	0.5
4	3	0.1
4	5	
4	6	0.6
4	7	0.8
4	8	

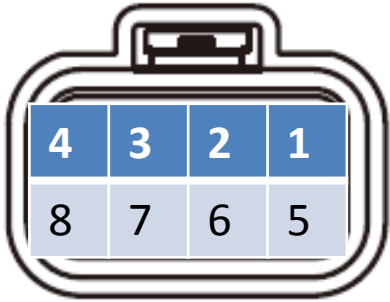

5	1	
5	2	
5	3	
5	4	
5	6	
5	7	
5	8	
6	1	
6	2	0.8
6	3	0.2
6	4	0.3
6	5	
6	7	0.8
6	8	

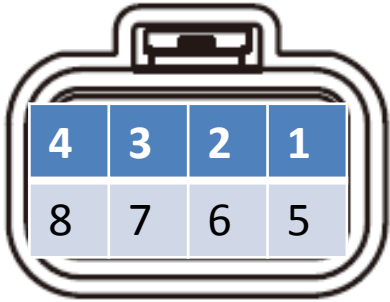

7	1	
7	2	
7	3	0.5
7	4	0.4
7	5	
7	6	1.0
7	8	
8	1	
8	2	
8	3	
8	4	
8	5	
8	6	
8	7	

1 2 3 4

NC	D01	D05	D06A
	1.25 L	1.25 B/W	1.25 R
NC	D02	D03	NC
	1.25 W/B	1.25 G	

5 6 7 8

ON 123		
1		
2		24.5V
3		0.8V
4		0.47V
5		
6		24.5V
7		24.4V
8		

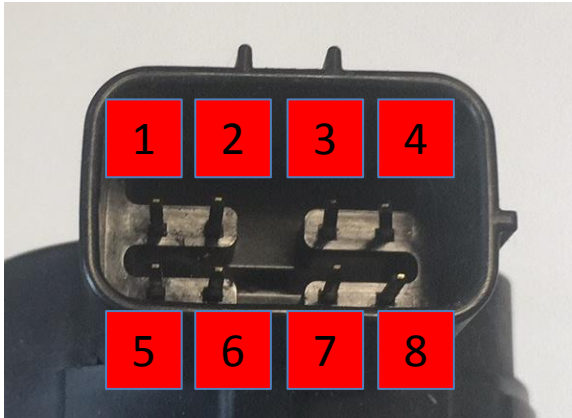

EGR		
1	2	2.6
1	3	2.6
1	4	1.3
1	5	
1	6	
1	7	
1	8	
2	1	2.6
2	3	2.6
2	4	1.3
2	5	
2	6	
2	7	
2	8	

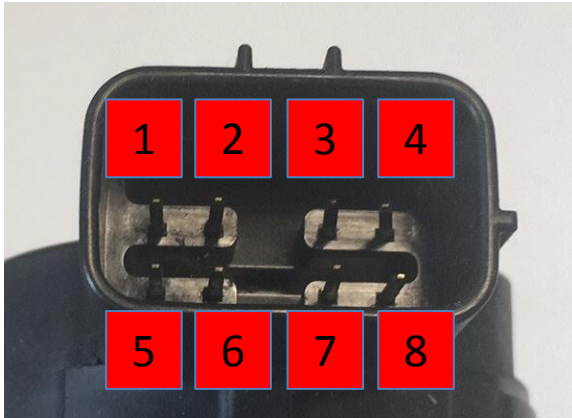

EGR		
3	1	2.6
3	2	2.6
3	4	1.3
3	5	
3	6	
3	7	
3	8	
4	1	1.3
4	2	1.3
4	3	1.3
4	5	
4	6	
4	7	
4	8	-----

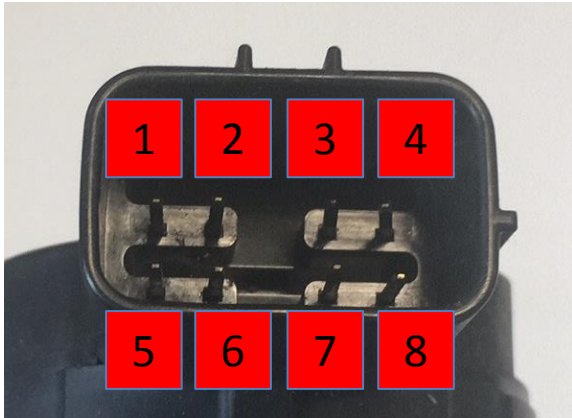

EGR		
5	1	
5	2	
5	3	
5	4	
5	6	10.4
5	7	10.1
5	8	
6	1	
6	2	
6	3	
6	4	
6	5	10
6	7	10
6	8	

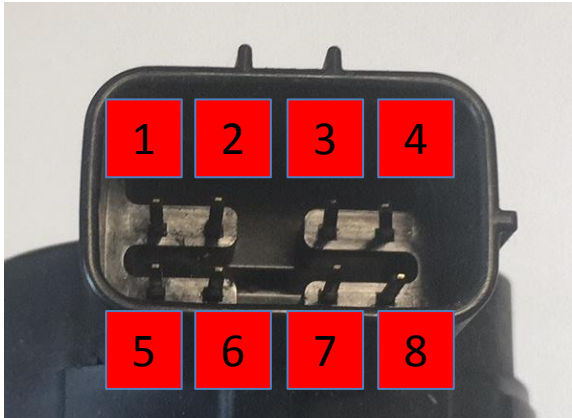

EGR		
7	1	
7	2	
7	3	
7	4	
7	5	10.1
7	6	10.1
7	8	
8	1	0.76
8	2	0.76
8	3	0.76
8	4	0.76
8	5	
8	6	
8	7	

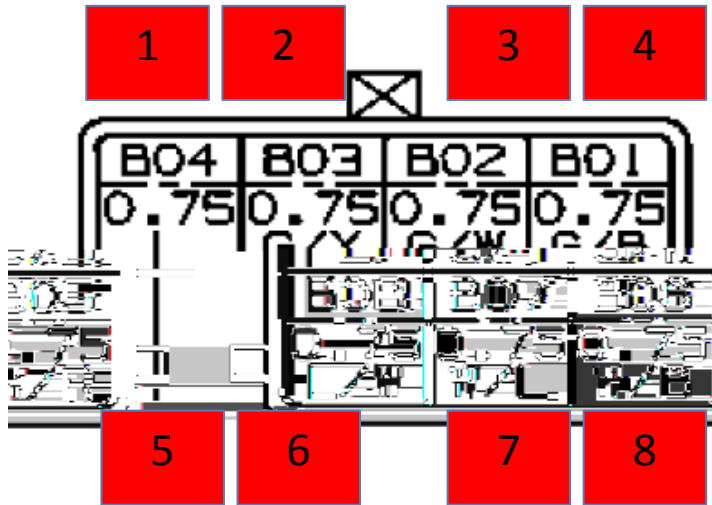

EGR		ON	
1			4.94V
2	W		0V
3	V		0V
4	U		0V
5			0V
6	EGR W		0.53V
7	EGR V		0.32V
8	EGR W		0V

